

Three Phase Rectifier Bridge

$$I_{dAV} = 25 \text{ A}$$

$$V_{RRM} = 800-1800 \text{ V}$$

V_{RSM} V_{DSM} V	V_{RRM} V_{DRM} V	Type
800	900	VUO 25-08NO8
1200	1300	VUO 25-12NO8
1400	1500	VUO 25-14NO8
1600	1700	VUO 25-16NO8
1800	1900	VUO 25-18NO8

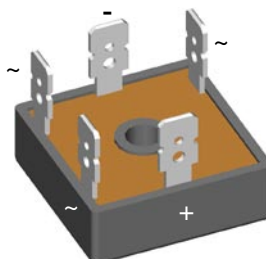
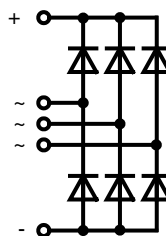

Symbol	Conditions	Maximum Ratings	
I_{dAV}	$T_C = 85^\circ\text{C}$, module	20	A
I_{dAVM}	$T_C = 63^\circ\text{C}$, module	25	A
I_{FSM}	$T_{VJ} = 45^\circ\text{C}$; $t = 10 \text{ ms}$ (50 Hz)	380	A
	$V_R = 0$; $t = 8.3 \text{ ms}$ (60 Hz)	400	A
	$T_{VJ} = T_{VJM}$; $t = 10 \text{ ms}$ (50 Hz)	360	A
	$V_R = 0$; $t = 8.3 \text{ ms}$ (60 Hz)	400	A
I^2t	$T_{VJ} = 45^\circ\text{C}$; $t = 10 \text{ ms}$ (50 Hz)	725	A ² s
	$V_R = 0$; $t = 8.3 \text{ ms}$ (60 Hz)	750	A ² s
	$T_{VJ} = T_{VJM}$; $t = 10 \text{ ms}$ (50 Hz)	650	A ² s
	$V_R = 0$; $t = 8.3 \text{ ms}$ (60 Hz)	650	A ² s
T_{VJ}		-40...+150	°C
T_{VJM}		150	°C
T_{stg}		-40...+150	°C
V_{ISOL}	50/60 Hz, RMS $t = 1 \text{ min}$	2500	V~
	$I_{ISOL} \leq 1 \text{ mA}$ $t = 1 \text{ s}$	3000	V~
M_d	Mounting torque (M5) (10-32 UNF)	2 ±10%	Nm
		18 ±10%	lb.in.
Weight	Typ.	22	g

Features

- Package with ¼" fast-on terminals
- Isolation voltage 3000 V~
- Planar passivated chips
- Blocking voltage up to 1800 V
- Low forward voltage drop
- UL registered E 72873

Applications

- Supplies for DC power equipment
- Input rectifiers for PWM inverter
- Battery DC power supplies
- Field supply for DC motors

Advantages

- Easy to mount with one screw
- Space and weight savings
- Improved temperature & power cycling

Dimensions in mm (1 mm = 0.0394")

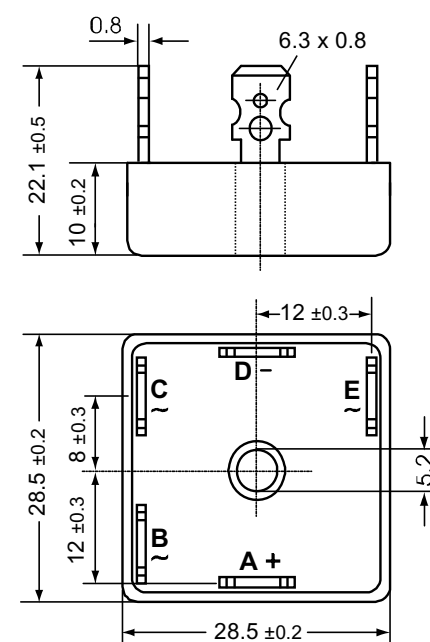

Symbol	Conditions	Characteristic Values	
I_R	$V_R = V_{RRM}$ $T_{VJ} = 25^\circ\text{C}$ $T_{VJ} = T_{VJM}$	0.3	mA
		5.0	mA
V_F	$I_F = 150 \text{ A}$ $T_{VJ} = 25^\circ\text{C}$	2.2	V
V_{TO}	For power-loss calculations only	0.85	V
r_t		12	mΩ
R_{thJC}	per diode; 120° el.	9.30	K/W
	per module	1.55	K/W
R_{thCH}	per diode; 120° el.	10.20	K/W
	per module	1.70	K/W
d_S	Creeping distance on surface	12.7	mm
d_A	Creepage distance in air	9.4	mm
a	Max. allowable acceleration	50	m/s ²

Data according to IEC 60747 and refer to a single diode unless otherwise stated.

IXYS reserves the right to change limits, test conditions and dimensions.

20070807

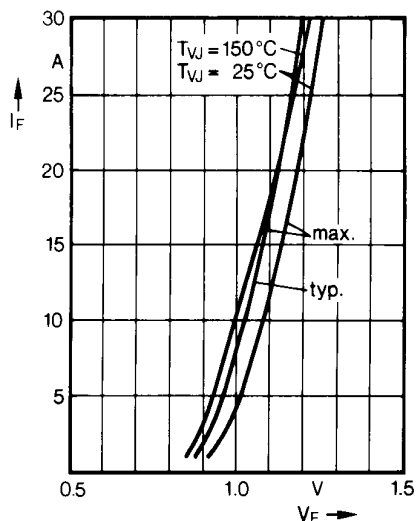

Fig. 1 Forward current versus voltage drop per diode

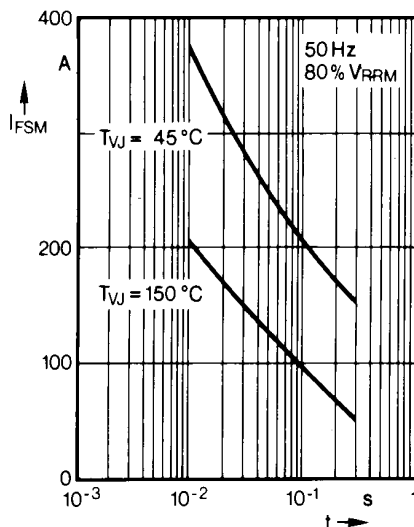

Fig. 2 Surge overload current per diode
 I_{FSM} : Crest value. t : duration

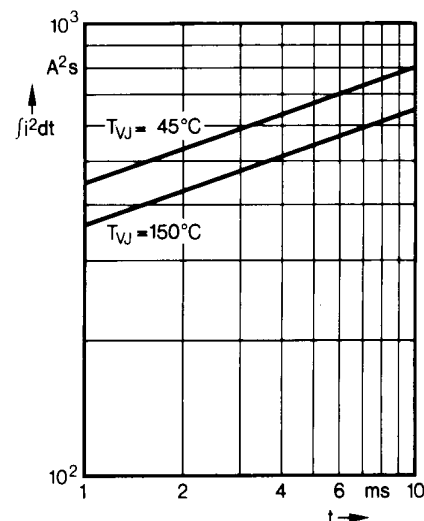

Fig. 3 I^2t versus time (1-10 ms) per diode

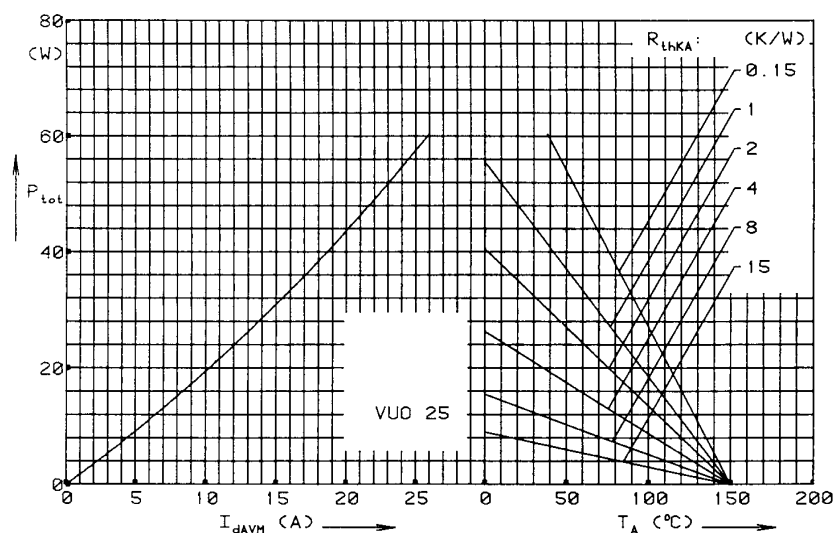

Fig. 4 Power dissipation versus direct output current and ambient temperature

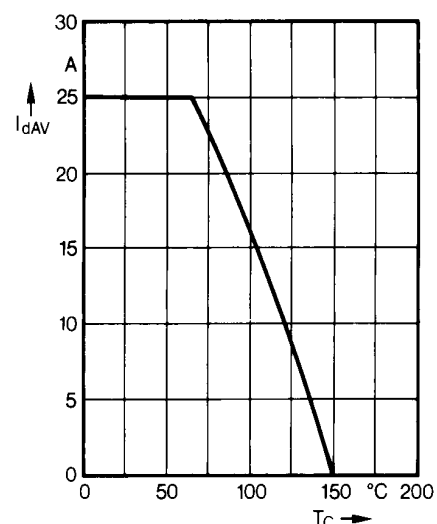

Fig. 5 Maximum forward current at case temperature

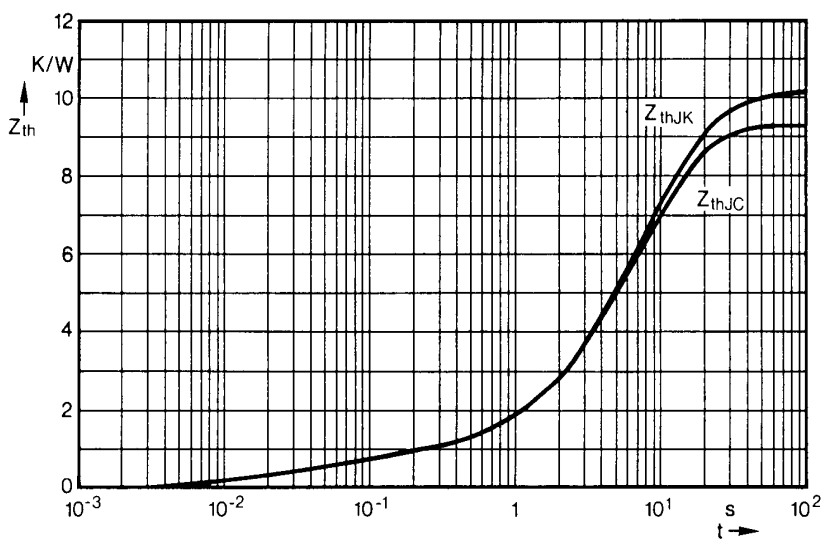

Fig. 6 Transient thermal impedance per diode

Constants for Z_{thJC} calculation:

i	R_{thi} (K/W)	t_i (s)
1	0.194	0.024
2	0.556	0.07
3	2.25	5.8
4	6.3	8.5

Constants for Z_{thJK} calculation:

i	R_{thi} (K/W)	t_i (s)
1	0.194	0.024
2	0.556	0.07
3	2.25	5.8
4	6.3	8.5
5	0.9	28